

GPDF, GPDB Exhaust valve

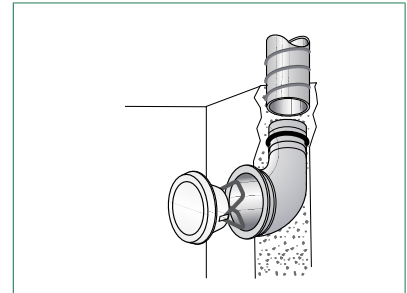
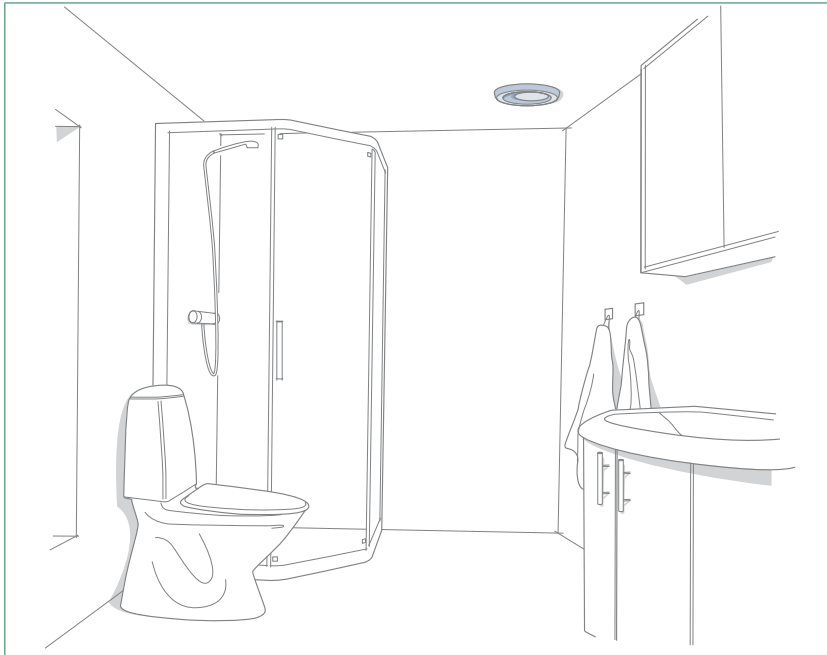

GPDF and GPDB are exhaust valves with universal application in the area of comfort ventilation. GPDF has a spring mounting and GPDB a bayonet mounting. GPDF and GPDB have a fixed setting for the basic flow.

Quick Selection

Size	Connection mm	Air flow range l/s at sound level		
		25 dB(A)	30 dB(A)	35 dB(A)
GPD(F,B)-100-C	100	33	40	48
GPD(F,B)-125-C	125	52	62	75
GPD(F,B)-160-C	160	80	97	115
GPDB-200-C	200	115	140	160

Specifications

- CleanVent coating as standard
- Exhaust valve with universal application
- Simple and symmetrical design
- Easy to install
- Manufactured of steel

Product code example

Exhaust valve GPDF-100-C

Mounting ring KGEZ-01-100

AIRTREND Ltd
 Predstavništvo u Beogradu
 Kumanovska 14, 11000 Beograd
 Tel: 011/3836886, 3085740
 Faks: 011/3444113
 e-mail: gobrid@eunet.rs
 web: www.airtrend.rs

Air flow, pressure drop, acoustical data GPDF /GPDB-100-C

Installed with Safety distance < 300 mm

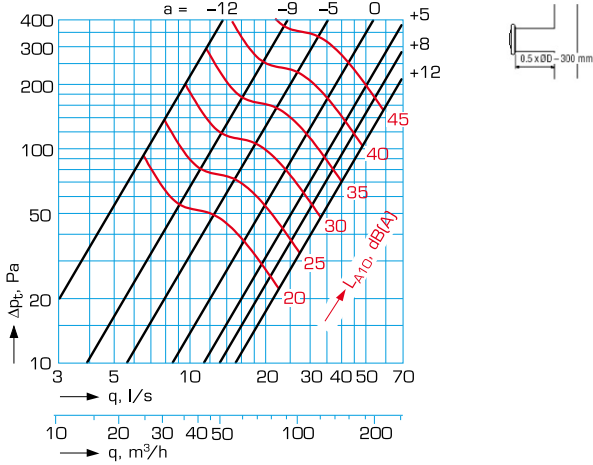

Sound power level in octave bands

Correction of sound level in dB at octave bands, middle frequency, Hz								
Size	63	125	250	500	1000	2000	4000	8000
100	11	4	2	-3	-2	-1	-7	-17
Tol.±	6	3	2	2	2	2	2	3

Installed in an angle duct

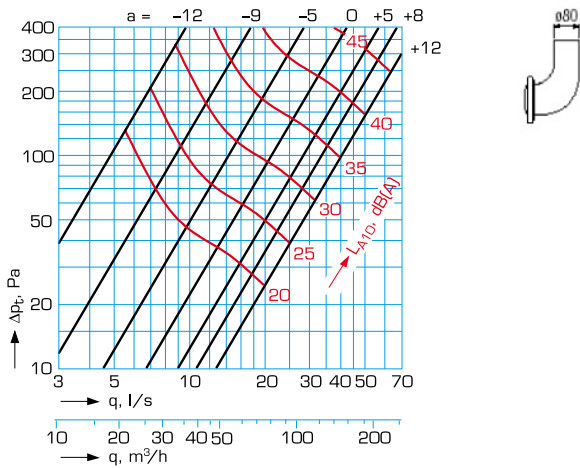

Sound power level in octave bands

Correction of sound level in dB at octave bands, middle frequency, Hz								
Size	63	125	250	500	1000	2000	4000	8000
100	3	3	1	1	-1	-3	-12	-23
Tol.±	6	3	2	2	2	2	2	3

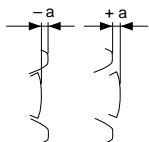

a = valve cone setting

Installed with Safety distance > 300 mm

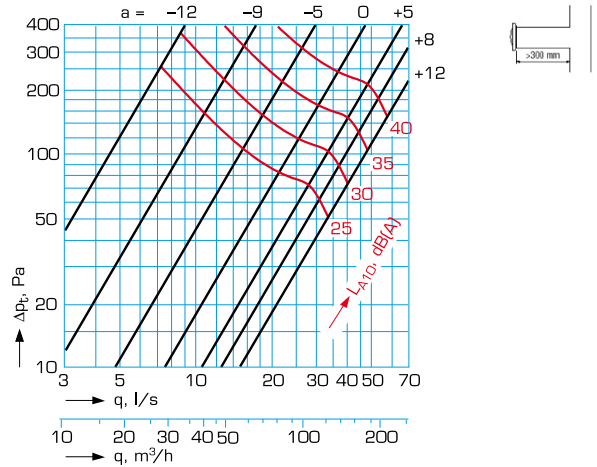

Sound power level in octave bands

Correction of sound level in dB at octave bands, middle frequency, Hz								
Size	63	125	250	500	1000	2000	4000	8000
100	8	0	-2	-3	-2	0	-9	-14
Tol.±	6	3	2	2	2	2	2	3

Sound attenuation from duct to room

Installed in a mounting ring

Setting	Sound attenuation in dB at octave bands, mean frequency, Hz							
	a	63	125	250	500	1000	2000	4000
-12	23	19	14	14	12	11	13	16
0	22	16	9	8	6	6	6	10
+8	22	16	9	7	5	5	4	8

Installed in an angle duct

Setting	Sound attenuation in dB at octave bands, mean frequency, Hz							
	a	63	125	250	500	1000	2000	4000
-12	25	20	15	13	12	12	12	15
0	24	17	11	7	6	7	6	11
+8	24	17	11	6	5	5	5	11

Sound attenuation from room to duct

Installed in a mounting ring

Setting	Sound attenuation in dB at octave bands, mean frequency, Hz							
	a	63	125	250	500	1000	2000	4000
-12	19	23	24	29	36	36	40	40
0	19	22	23	26	32	32	34	36
+8	20	22	22	26	30	30	33	34

Installed in an angle duct

Setting	Sound attenuation in dB at octave bands, mean frequency, Hz							
	a	63	125	250	500	1000	2000	4000
-12	18	21	25	33	39	37	36	33
0	16	17	22	28	33	32	33	33
+8	15	19	22	27	32	31	33	33

Air flow, pressure drop, acoustical data GPDF/GPDB-125-C

Installed with Safety distance < 300 mm

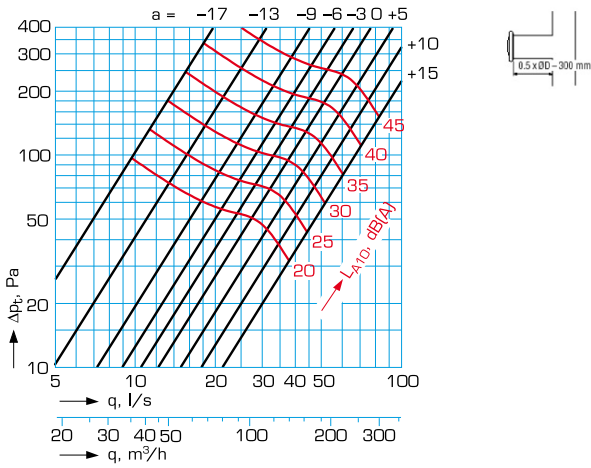

Sound attenuation from room to duct

Setting	Sound attenuation in dB at octave bands, mean frequency, Hz							
	a	63	125	250	500	1000	2000	4000
-17	17	22	30	29	32	33	36	37
-6	16	20	26	26	29	30	32	33
+5	16	20	23	25	28	28	30	32

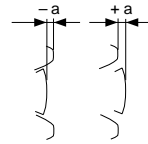

a = valve cone setting

Sound power level in octave bands

Size	Correction of sound level in dB at octave bands, middle frequency, Hz							
	63	125	250	500	1000	2000	4000	8000
125	11	4	2	-3	-2	-1	-9	-20
Tol±	6	3	2	2	2	2	2	3

Installed with Safety distance > 300 mm

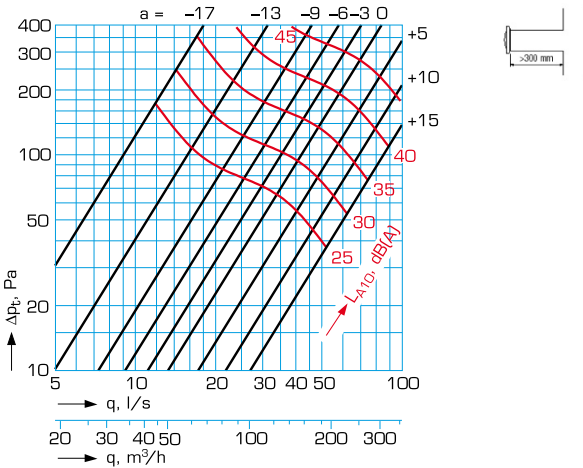

Sound power level in octave bands

Size	Correction of sound level in dB at octave bands, middle frequency, Hz							
	63	125	250	500	1000	2000	4000	8000
125	10	3	1	-2	-3	0	-12	-23
Tol±	6	3	2	2	2	2	2	3

Sound attenuation from duct to room

Setting	Sound attenuation in dB at octave bands, mean frequency, Hz							
	a	63	125	250	500	1000	2000	4000
-17	21	15	12	10	8	8	11	14
-6	20	14	10	7	5	5	6	7
+5	19	14	9	6	4	4	4	8

Air flow, pressure drop, acoustical data GPDF /GPDB-160-C

Installed with Safety distance < 300 mm

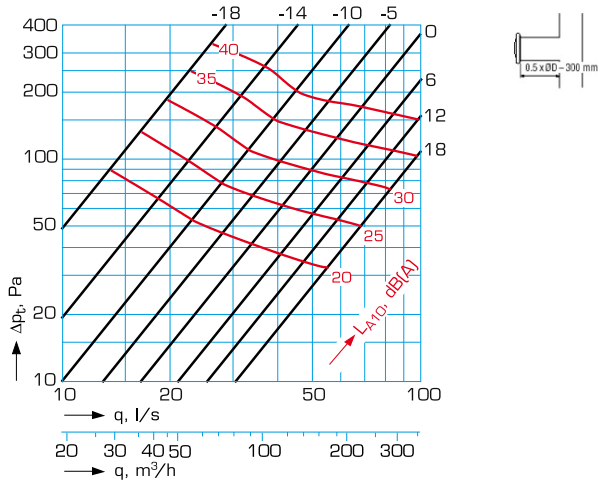

Sound attenuation from room to duct

Setting a	Sound attenuation in dB at octave bands, mean frequency, Hz							
	63	125	250	500	1000	2000	4000	8000
-18	15	20	20	27	28	31	34	34
-5	16	20	20	25	26	28	30	32
+6	17	19	20	23	25	26	30	30

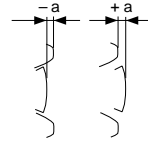

a = valve cone setting

Sound power level in octave bands

Size	Correction of sound level in dB at octave bands, middle frequency, Hz							
	63	125	250	500	1000	2000	4000	8000
160	9	5	-1	-4	-2	0	-14	-25
Tol±	6	3	2	2	2	2	2	3

Installed with Safety distance > 300 mm

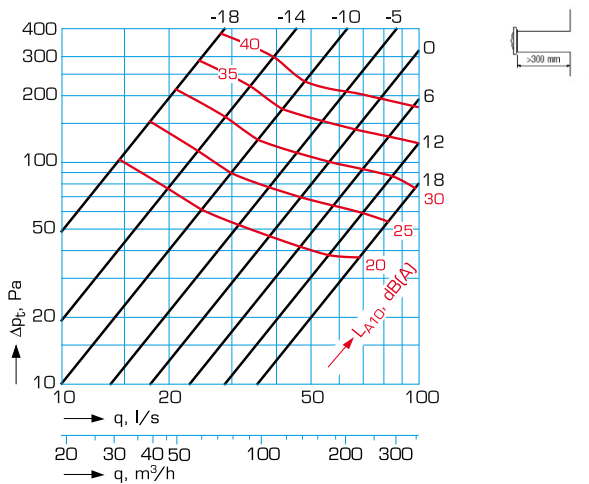

Sound power level in octave bands

Size	Correction of sound level in dB at octave bands, middle frequency, Hz							
	63	125	250	500	1000	2000	4000	8000
160	9	-1	0	-2	1	-3	-14	-26
Tol±	6	3	2	2	2	2	2	3

Sound attenuation from duct to room

Setting a	Sound attenuation in dB at octave bands, mean frequency, Hz							
	63	125	250	500	1000	2000	4000	8000
-18	19	14	10	8	7	9	13	13
-5	18	13	8	6	5	5	10	8
+6	18	12	7	5	4	4	10	6

Air flow, pressure drop, acoustical data GPDB-200-C

Installed with Safety distance < 300 mm

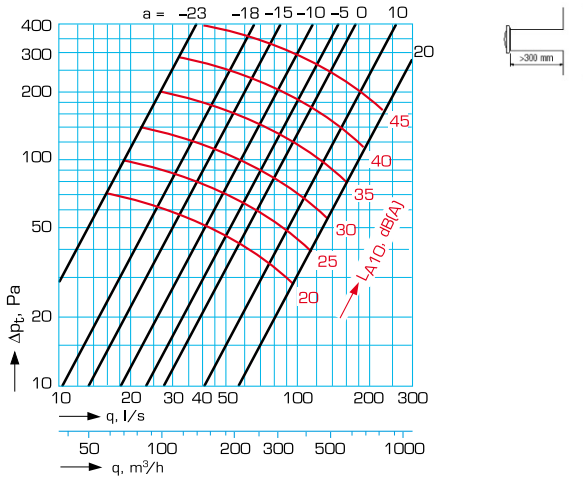

Dimensions and weights

GPDF/GPDB

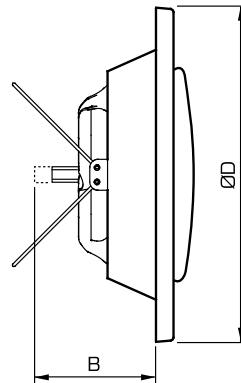

Size	B [mm]	ØD [mm]	Weight [kg]
GPDF/B-100-C	67	132	0.17
GPDF/B-125-C	74	162	0.25
GPDF/B-160-C	83	193	0.35
GPDB-200-C	100	245	0.50

Sound power level in octave bands

Size	Correction of sound level in dB at octave bands, mean frequency, Hz							
	63	125	250	500	1000	2000	4000	8000
200	7	2	-1	-2	2	-5	-12	-22
Tol±	6	3	2	2	2	2	2	3

Sound attenuation from duct to room

Setting	Sound attenuation in dB at octave bands, mean frequency, Hz							
	a	63	125	250	500	1000	2000	4000
-20	17	14	9	8	8	10	11	12
0	17	12	7	5	5	6	8	8
+20	15	12	6	24	3	4	8	7

Sound attenuation from room to duct

Setting	Sound attenuation in dB at octave bands, mean frequency, Hz							
	a	63	125	250	500	1000	2000	4000
-20	15	25	24	26	26	31	31	32
0	12	22	21	24	24	26	30	28
+20	12	19	20	24	22	25	30	27

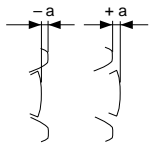

a = valve cone setting

Mounting rings KKT, KKU

KKT

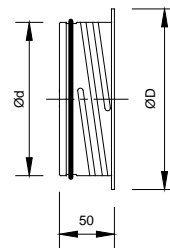

KKU

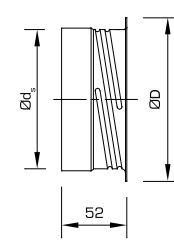

Size	Ød	ØD	Øds	Weight	
	[mm]	[mm]		KKT [g]	KKU [g]
100	99	122	100	75	71
125	124	148	125	102	97
160	159	184	160	131	125
200	199	225	200	165	156

Mounting rings KGEZ-01, KGEZ-05

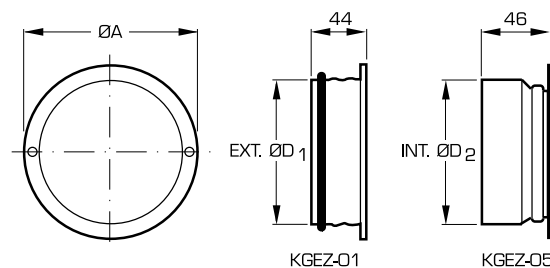

Size	A	ØD1	ØD2	Hole ¹⁾	Weight
	[mm]	[mm]	[mm]	[mm]	[kg]
100	123	99.3	100	110	0.10
125	149	124.3	125	135	0.10
160	185	159.3	160	170	0.16

¹⁾Tolerance hole +5/-0 mm

Angle duct KGEZ-43

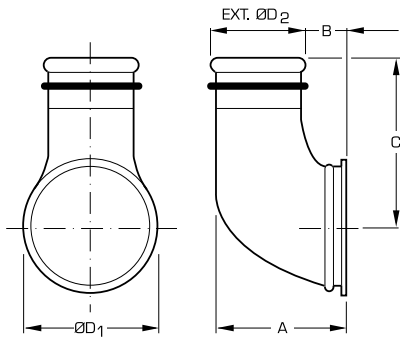

Size	A	B	C	D_1	D_2	Weight
	[mm]	[mm]	[mm]	[mm]	[mm]	[kg]
100 - 080	120	39	148	125	79.3	0.4
100 - 100	140	39	98	125	99.3	0.4
125 - 080	115	36	162	131	79.3	0.4
125 - 100	146	45	120	140	99.3	0.5

Application, material and instructions

Application

GPDF and GPDB are exhaust valves with universal application in the area of comfort ventilation. GPDF has a spring mounting. GPDB has a bayonet mounting. GPDF and GPDB have a fixed setting for the basic flow.

Both variants consist of an inlet ring and a valve cone. The inlet ring has a foam rubber seal against the mounting ring/wall.

The devices have a simple and symmetrical design, which matches all interiors, and are easy to install.

GPDF and GPDB have a lockable adjustment and are easily pre-set to the estimated pressure drop for a given air flow.

GPDF/GPDB can also be used as a supply air terminal device for a low air flow in areas where no particular requirements are imposed on the air flow or its diffusion, for example in changing rooms and apartment storage areas, etc.

When changing from older GPD to GPDF the old GP-ring can be used except ring size 012 ($d=125$). In such cases GPDF-100-125 can be used.

Material and surface finish

The valve is made of hot galvanized steel sheet and it meets the requirements for corrosivity class C2 in accordance with EN ISO 12944-2.

The valve is powder coated for a high surface finish and good impact and scratch resistance.

Standard colour is white (RAL9010). CleanVent coating as standard. Other colours on request.

Instructions

Directions for installation, adjustment and care are set out in detail in our technical instruction which accompanies each product. The instruction is also accessible on www.flaktgroup.com.

Technical data and dimensioning

For complete dimensioning details, please see FläktGroup product selection program. Contact our nearest sales office for further information.

Descriptive text

Exhaust valve GPDF, GPDB manufactured by FläktGroup.

Product code

Exhaust valve, spring mounting

Size (aaa)

100, 125, 160

Surface finish (b)

C = Standard CleanVent coating

E = Special Colour

GPDF-aaa-b

Exhaust valve, bayonet mounting

Size (aaa)

100, 125, 160, 200

Surface finish (b)

C = Standard CleanVent coating

E = Special Colour

GPDB-aaa-b

Special version:

Exhaust valve, size 100

Spring mounting for GP-frame 125 mm
incl. cover plate ØDy = 145 mm

GPDF-100-125

Accessories and spare parts

Accessories

Mounting ring, fit-in connection
with rubber seal

KKT-aaa

Mounting ring, fit-on connection
without rubber seal

KKU-aaa

Size (aaa)

100, 125, 160, 200

Mounting ring, fit-in connection

KGEZ-01-aaa

Mounting ring, fit-on connection

KGEZ-05-aaa

Size (aaa)

100, 125, 160

Angle duct for GPDF-100,125

KGEZ-43-aaa-bbb

Size (aaa-bbb)

Connection diameter in mm to valve - to duct
100-080, 100-100, 125-080, 125-100

Cover plate for GPDF-100-125

GPDZ-4

Spare parts

Seal

COGZ-aaa-6

Spring

COSZ-aaa-1

Size (aaa)

100, 125, 160